

2a

1a

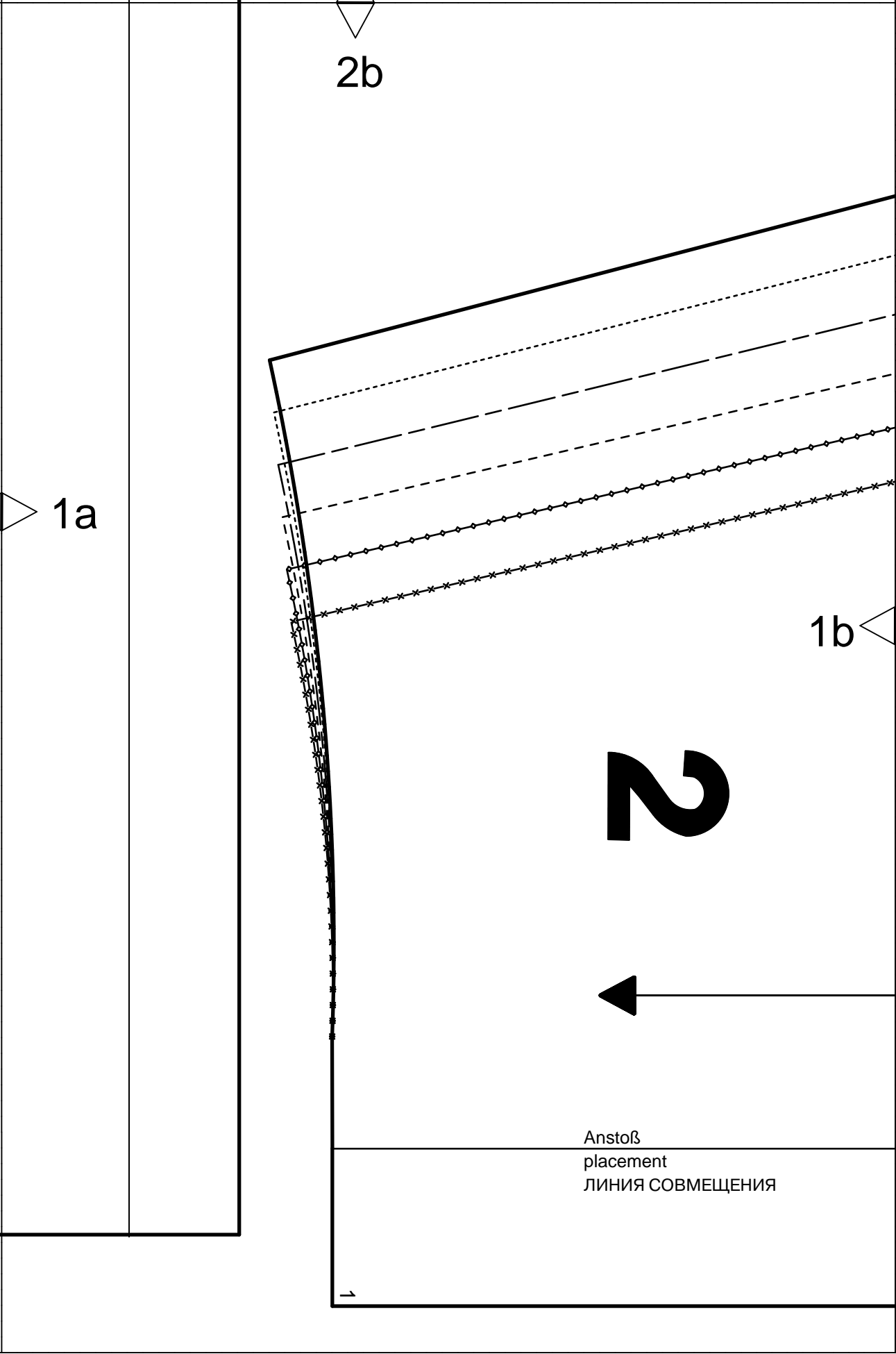

2b

1a

1b

**B**

Anstoß  
placement  
ЛИНИЯ СОВМЕЩЕНИЯ

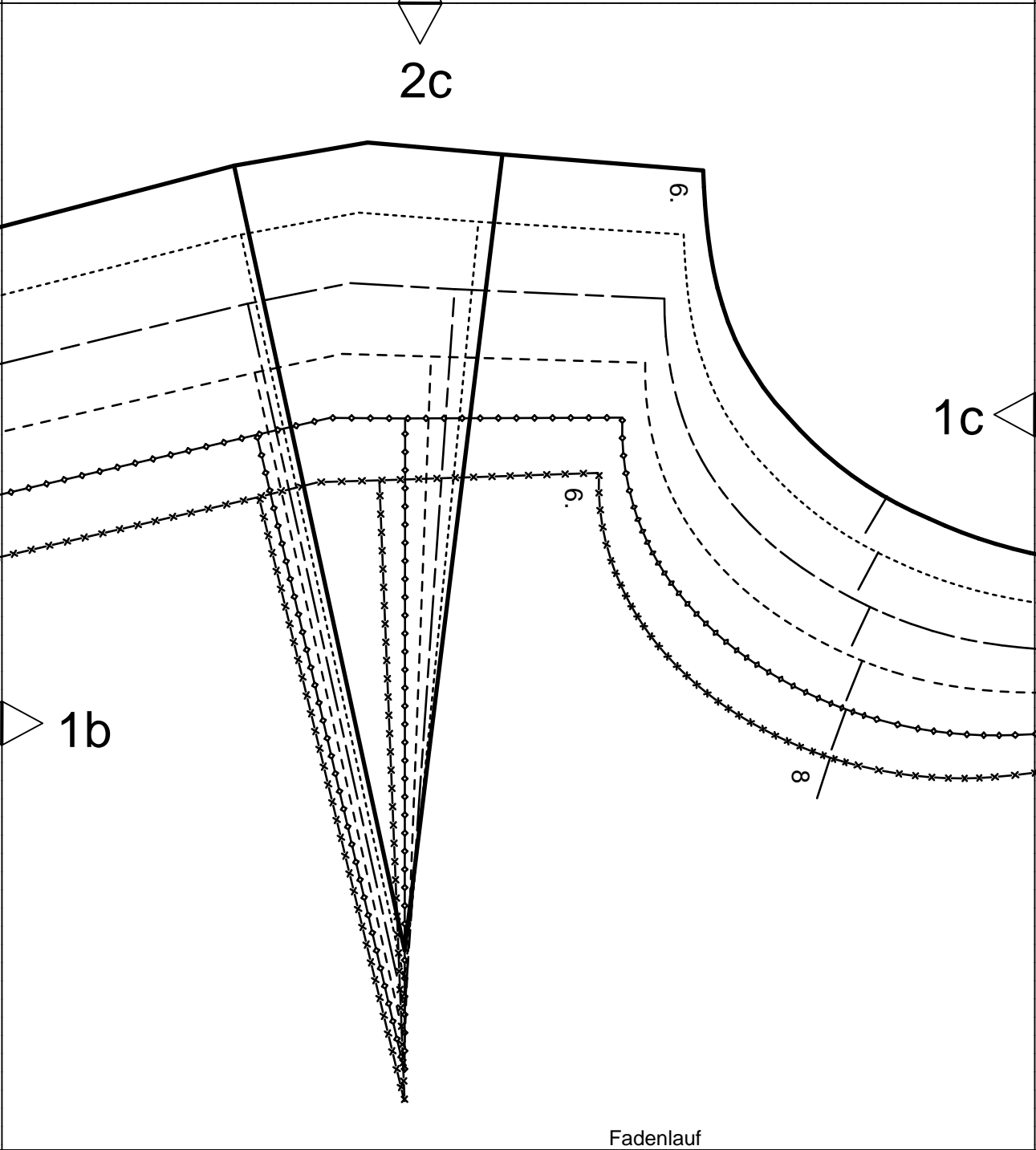

Fadenlauf  
 straight grain  
 ДОЛЕВАЯ НИТЬ

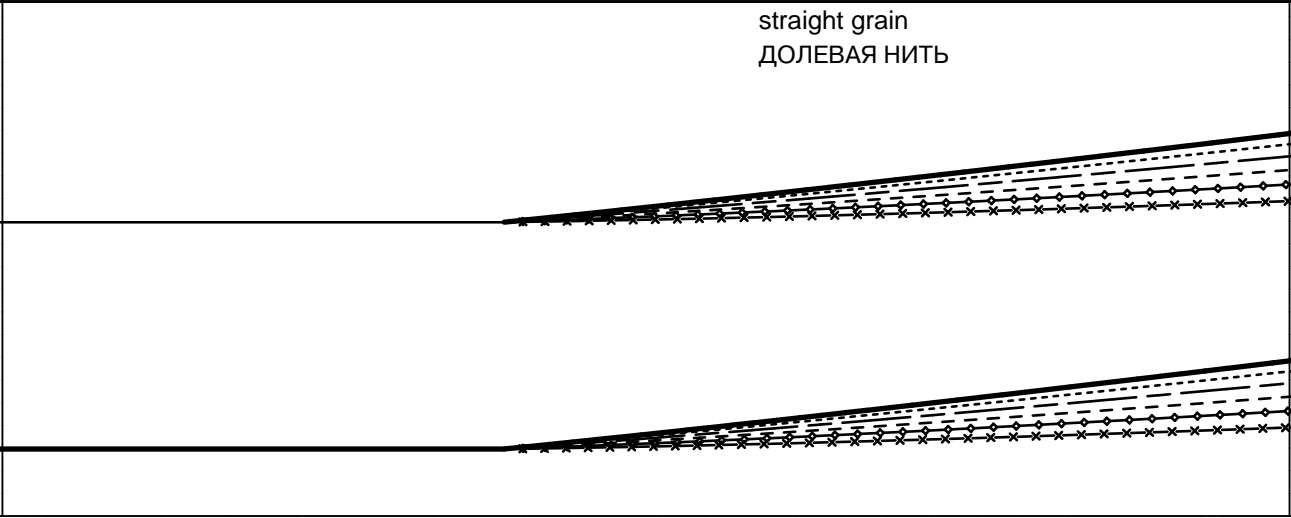

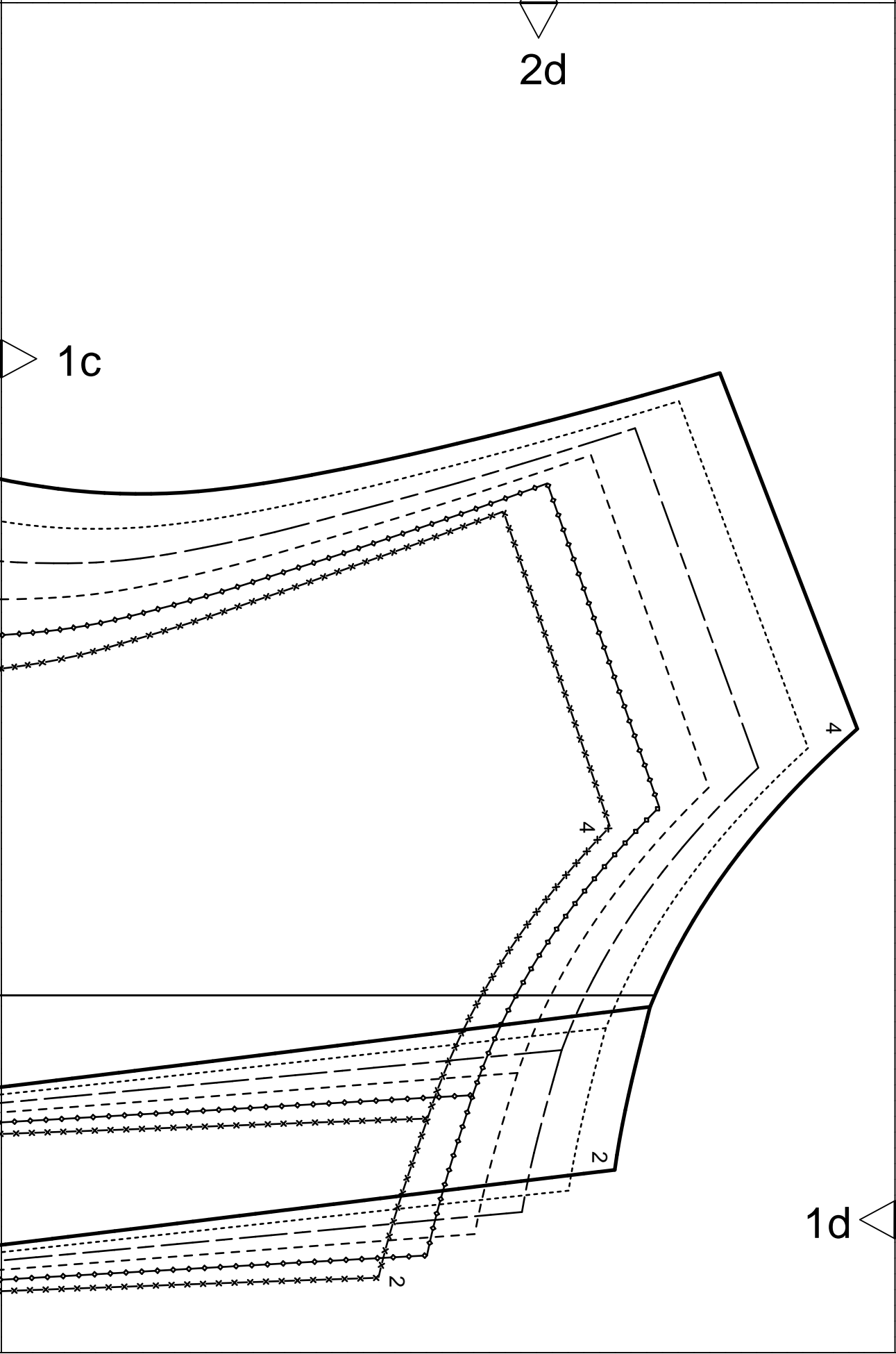

2e

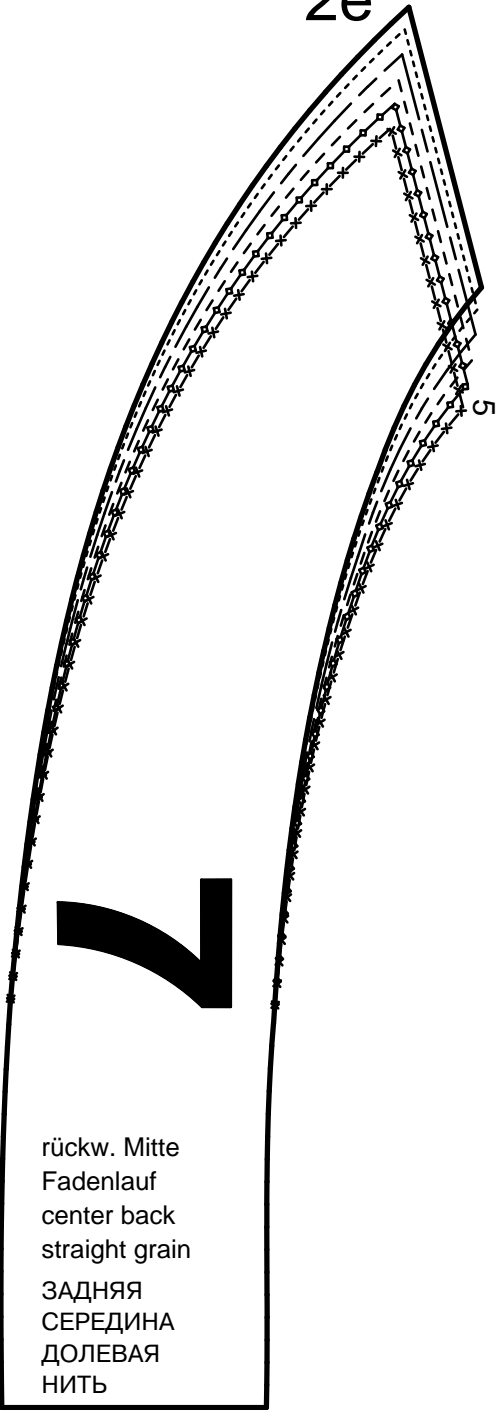

rückw. Mitte  
Fadenlauf  
center back  
straight grain

ЗАДНЯЯ  
СЕРЕДИНА  
ДОЛЕВАЯ  
НИТЬ

vordere Mitte  
Stoffbruch Fadenlauf  
center front fold  
straight grain  
ЛИНИЯ СЕРЕДИНЫ  
ПЕРЕДА СГИБ  
ДОЛЕВАЯ НИТЬ



1e

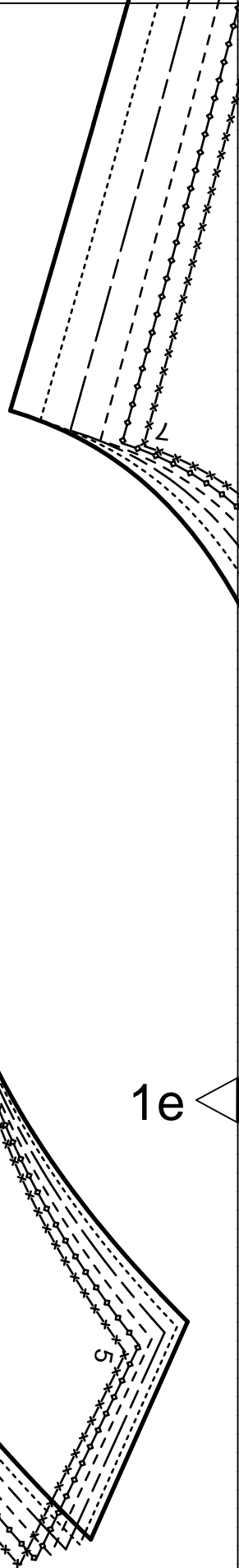

1d

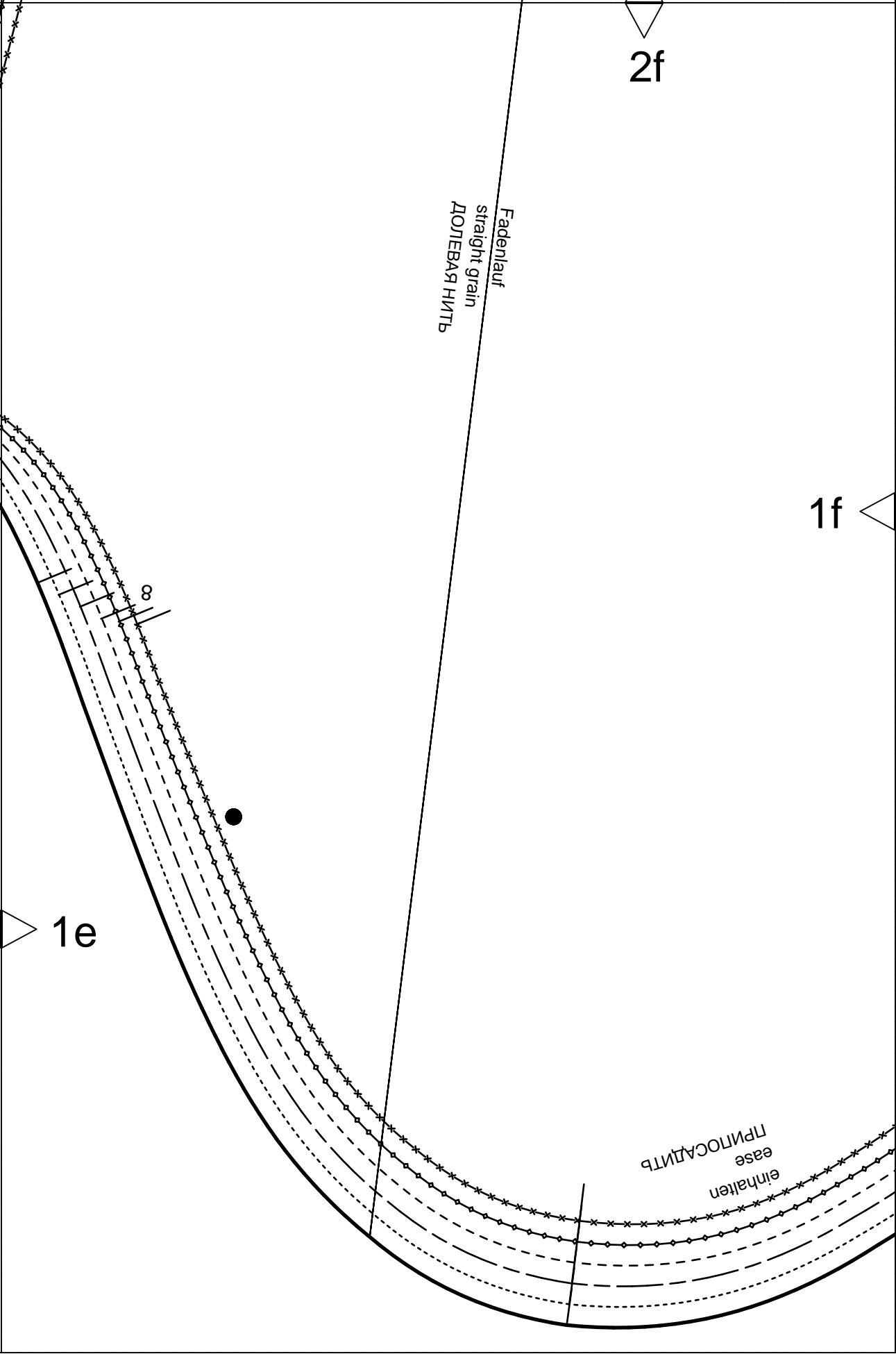

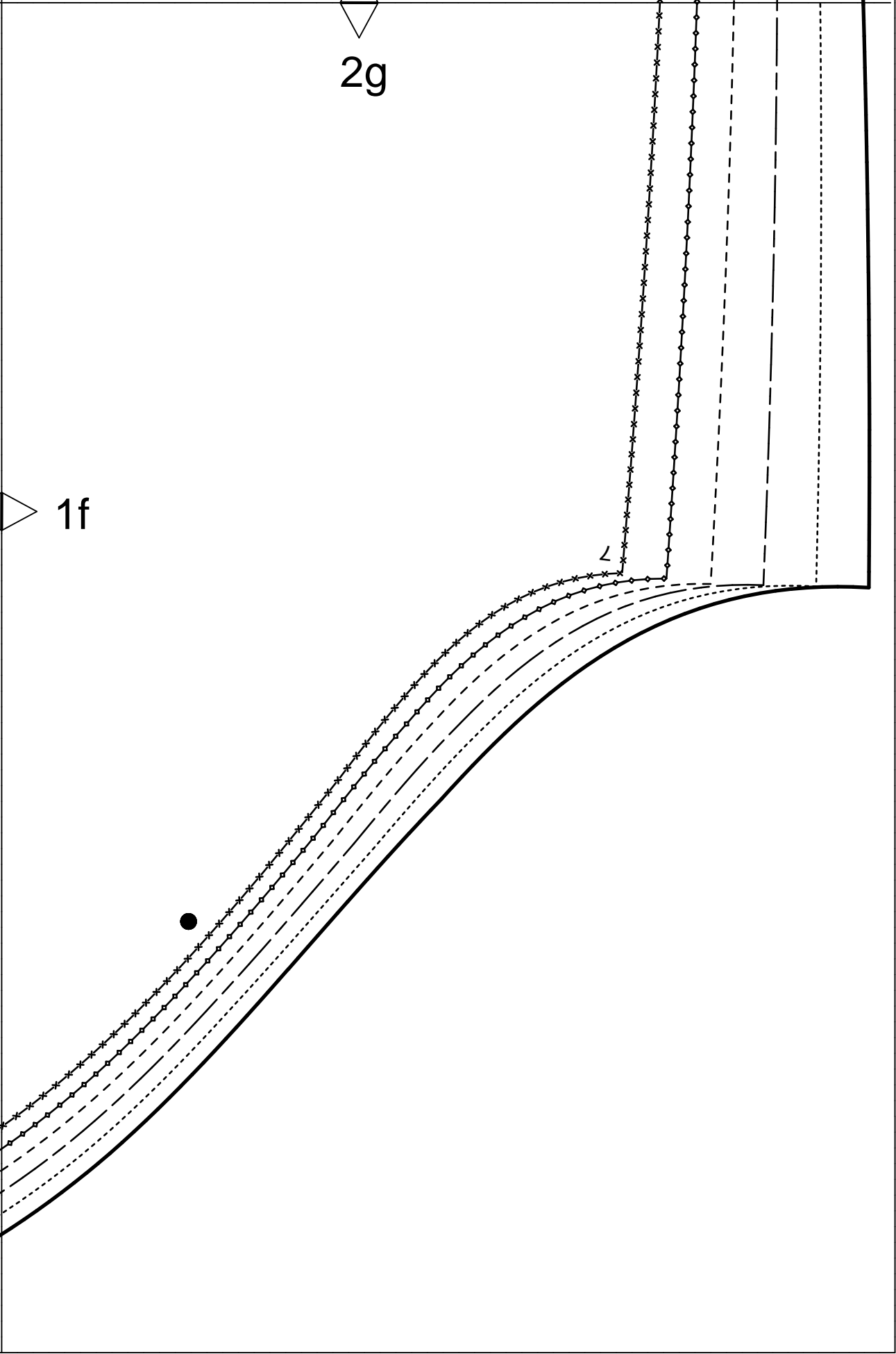

4a



3a



2a



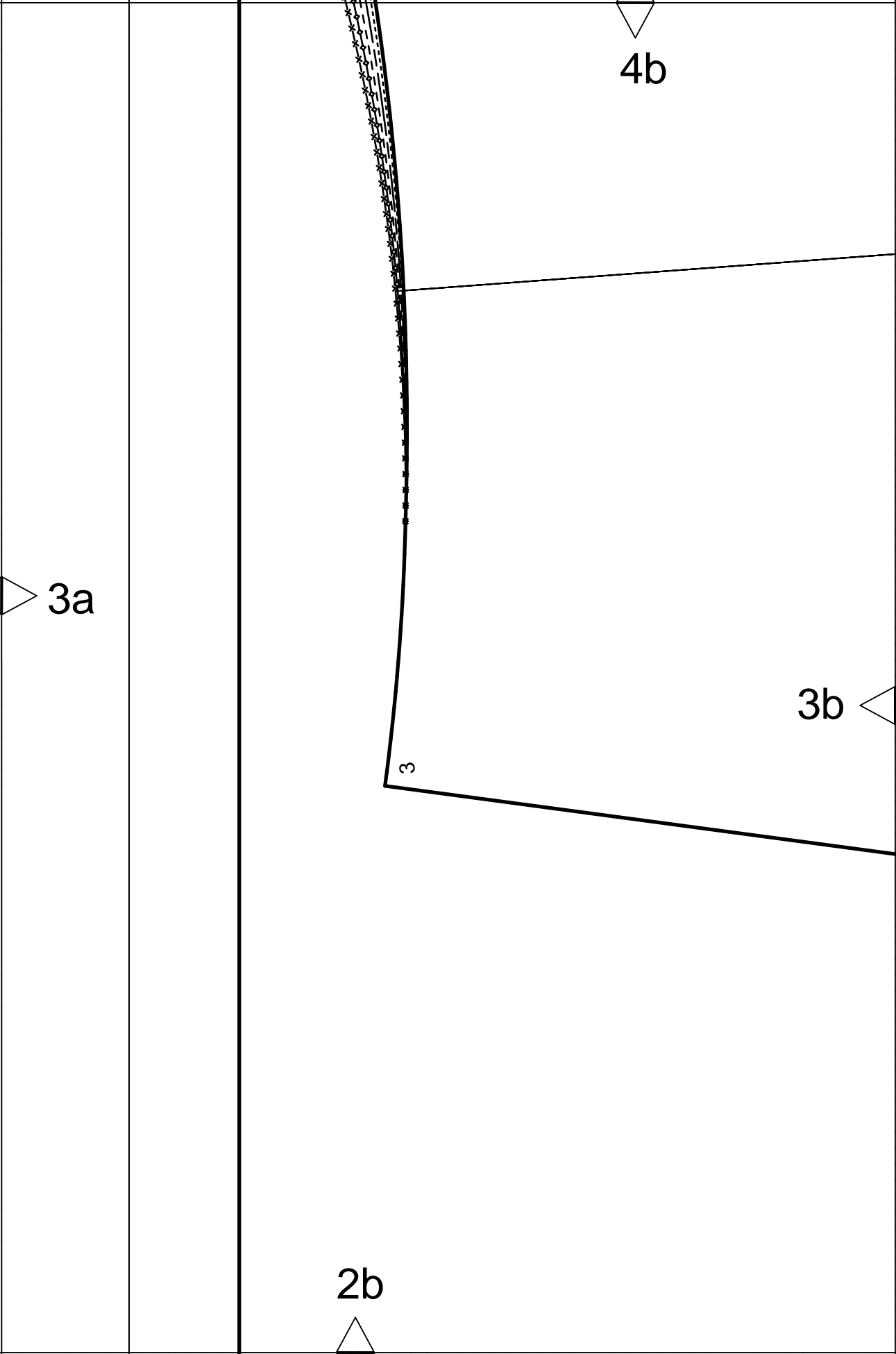

4c

Долгая нить  
straight grain  
Fadenlauf

3b

Защелка-молния  
zipper  
Reißverschluss

44

34

3c

2c

4d

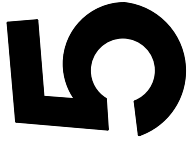

3d

3c

3АДННЯ СЕРЕДИНА ШОВ  
center back seam  
rückwärtige Mitte Naht

2d

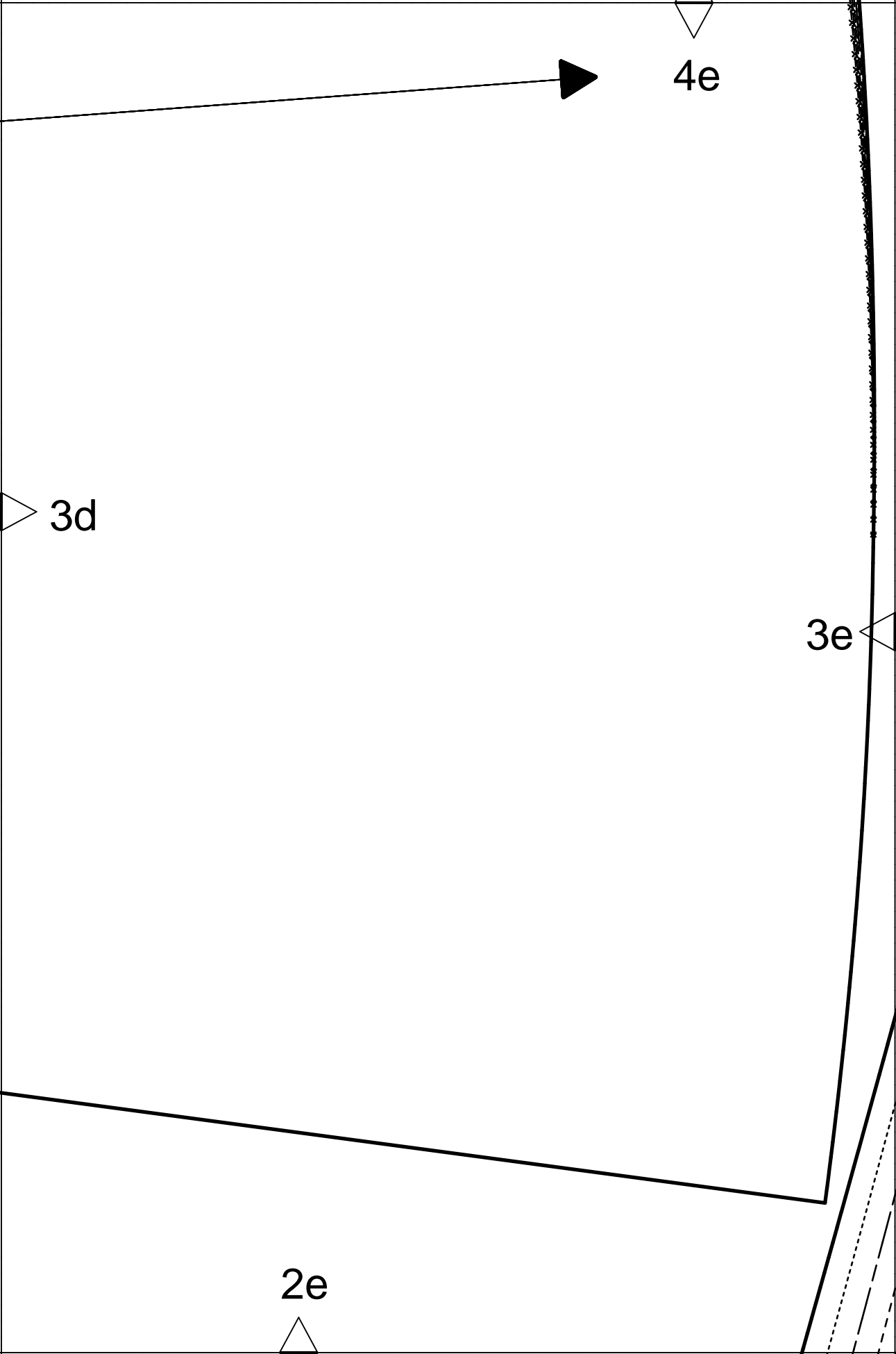

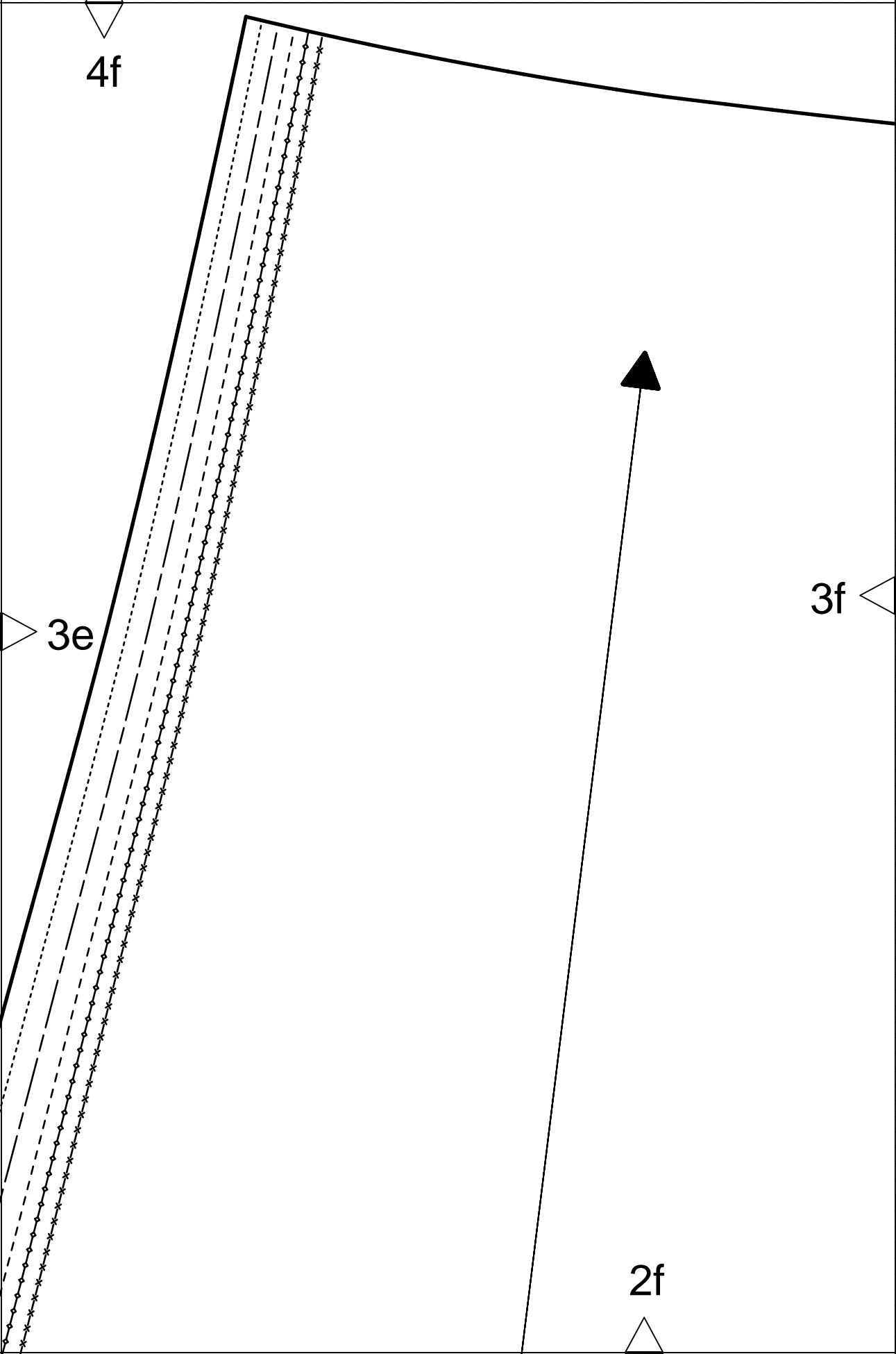

4g

3f

8

2g

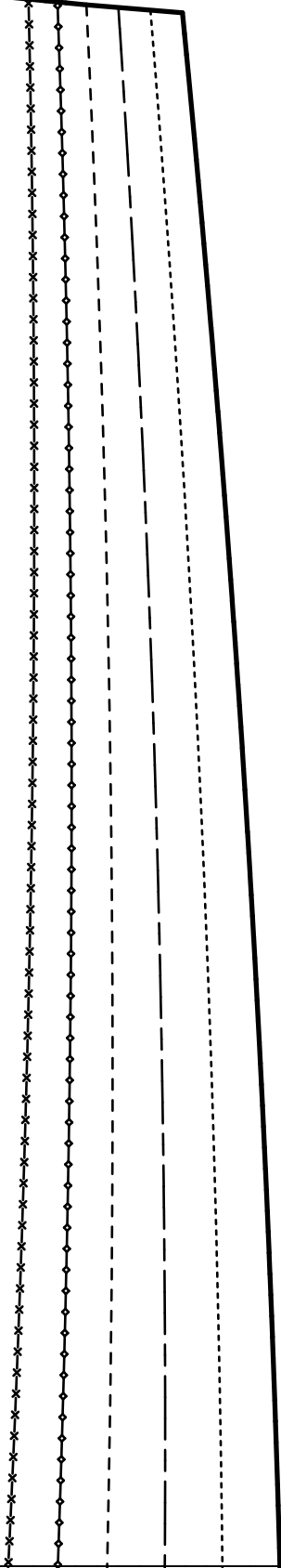

Faltenbruch  
pleat fold  
СГИБ СКЛАДКИ

6a

**1**

5a

4a

Falte  
pleat  
СКЛАДКА

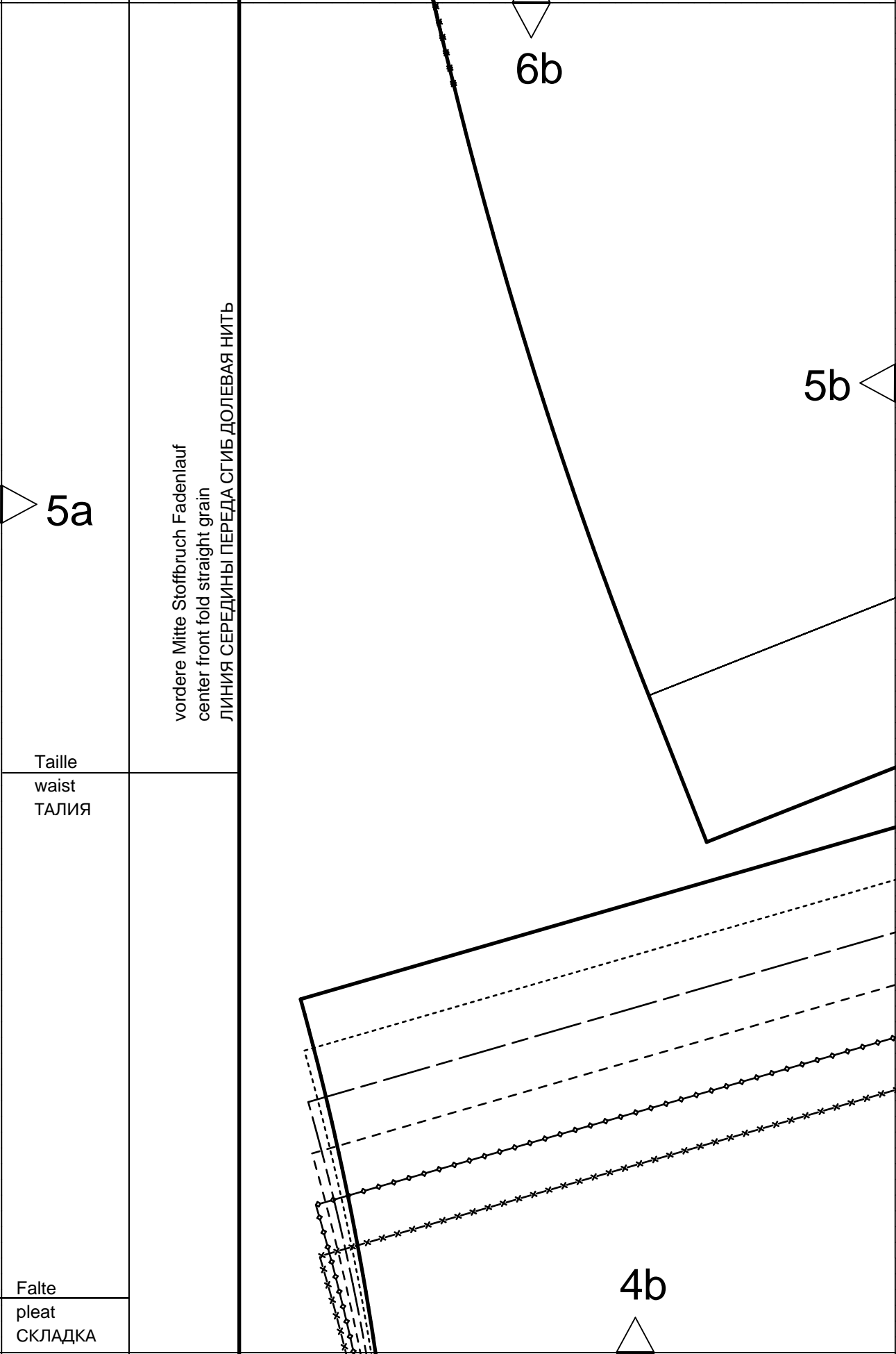

5a

6b

5b

4b

vordere Mitte Stoffbruch Fadenlauf  
center front fold straight grain  
ЛИНИЯ СЕРЕДИНЫ ПЕРЕДА СГИБ ДОЛБЕВАЯ НИТЬ

Taille  
waist  
ТАЛИЯ

Falte  
pleat  
СКЛАДКА

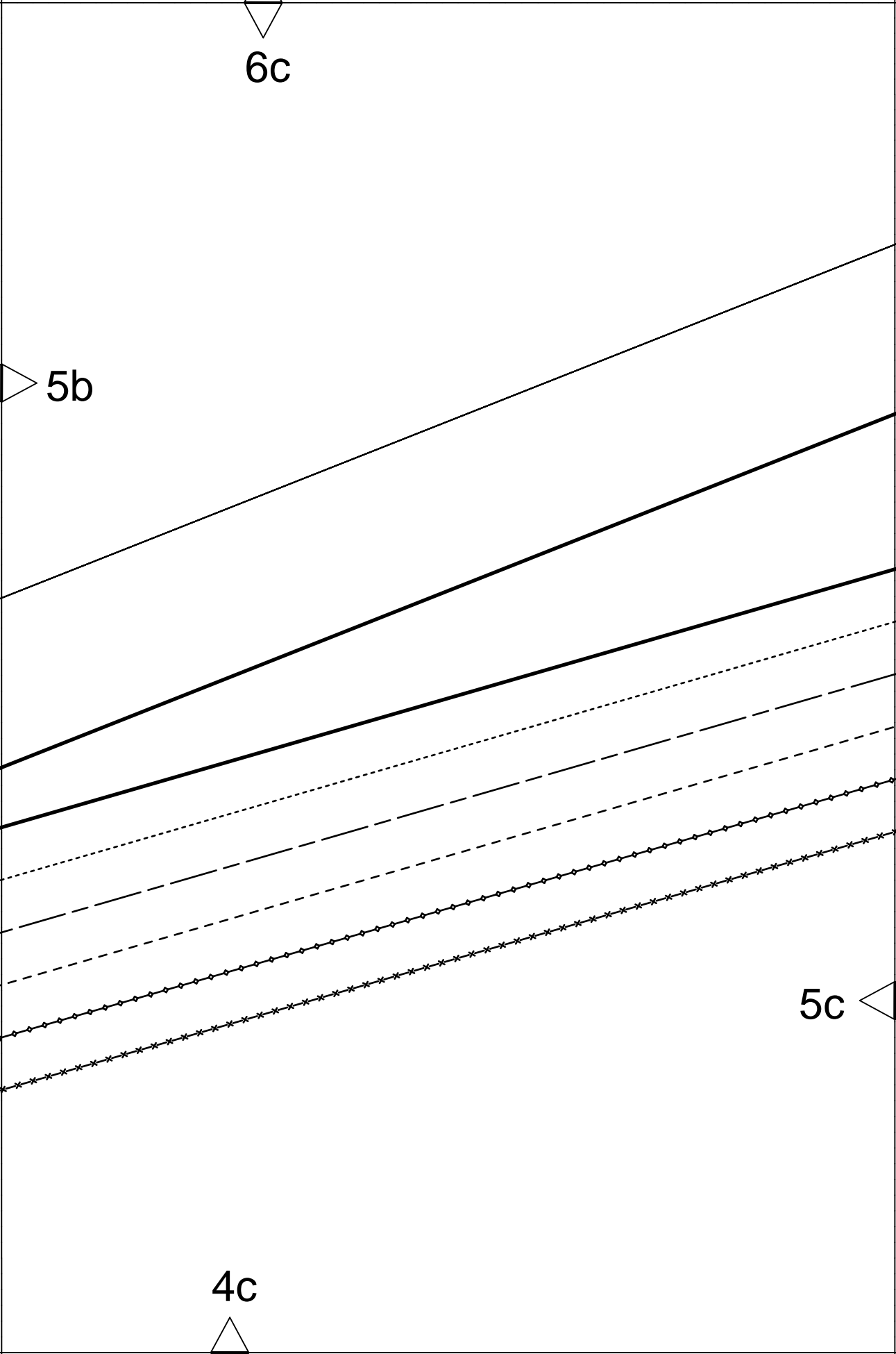

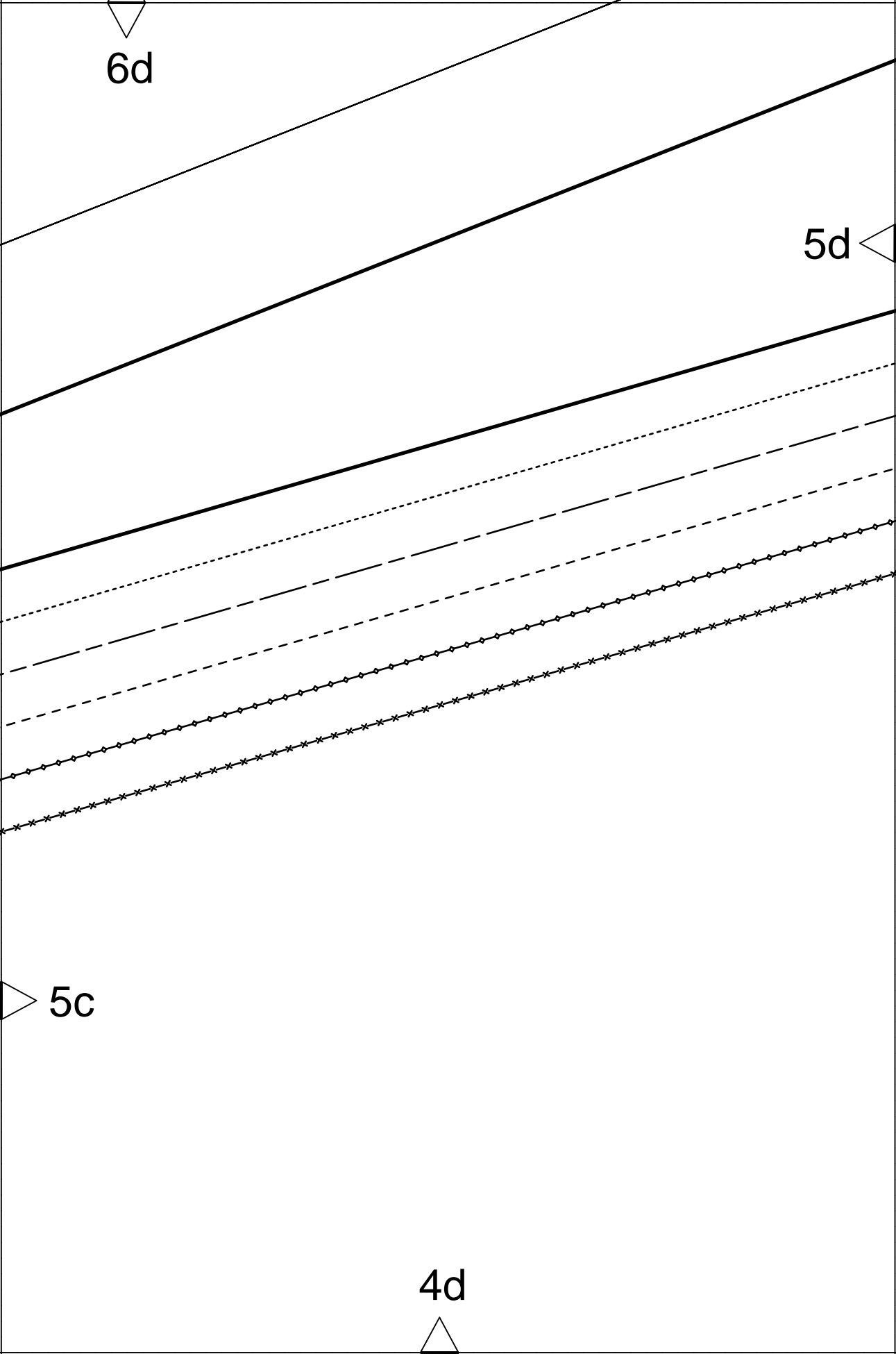

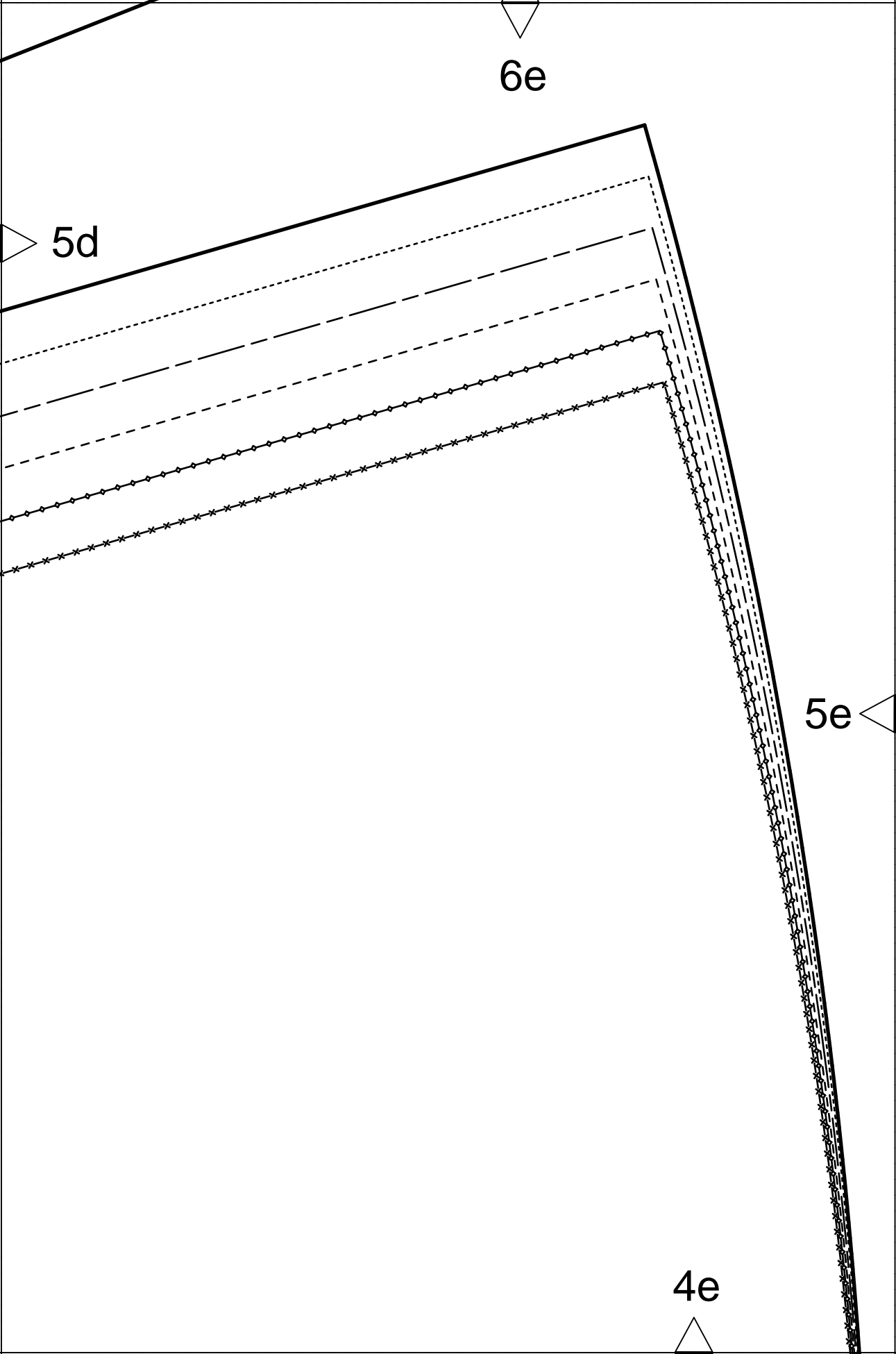

6f

Kontrollquadrat / test square

Seitenlänge / side length  
10 cm (4 inches)

5e

**burda**<sup>®</sup>  
www.burdastyle.de

5f

4f

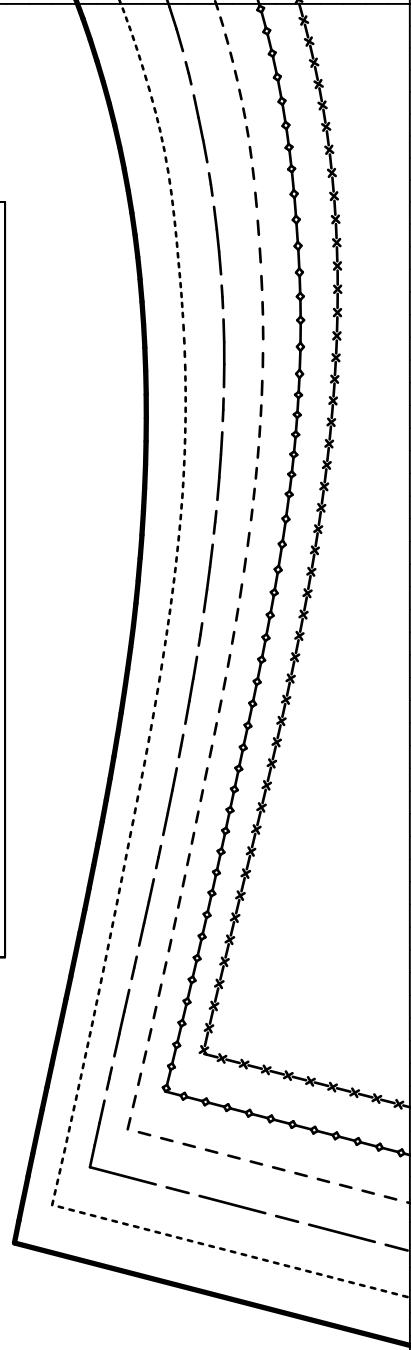

6g

$\mathcal{E}$

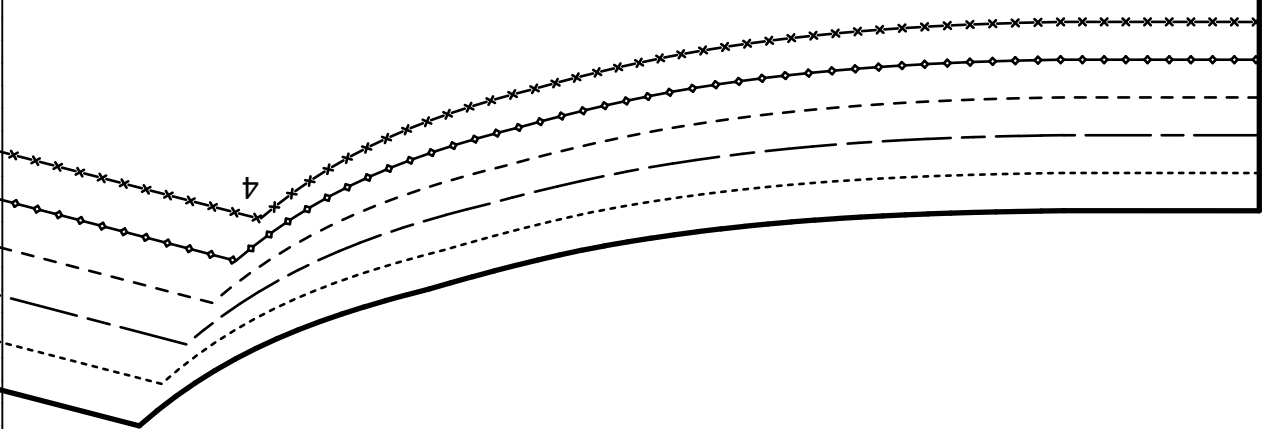

5f

4g

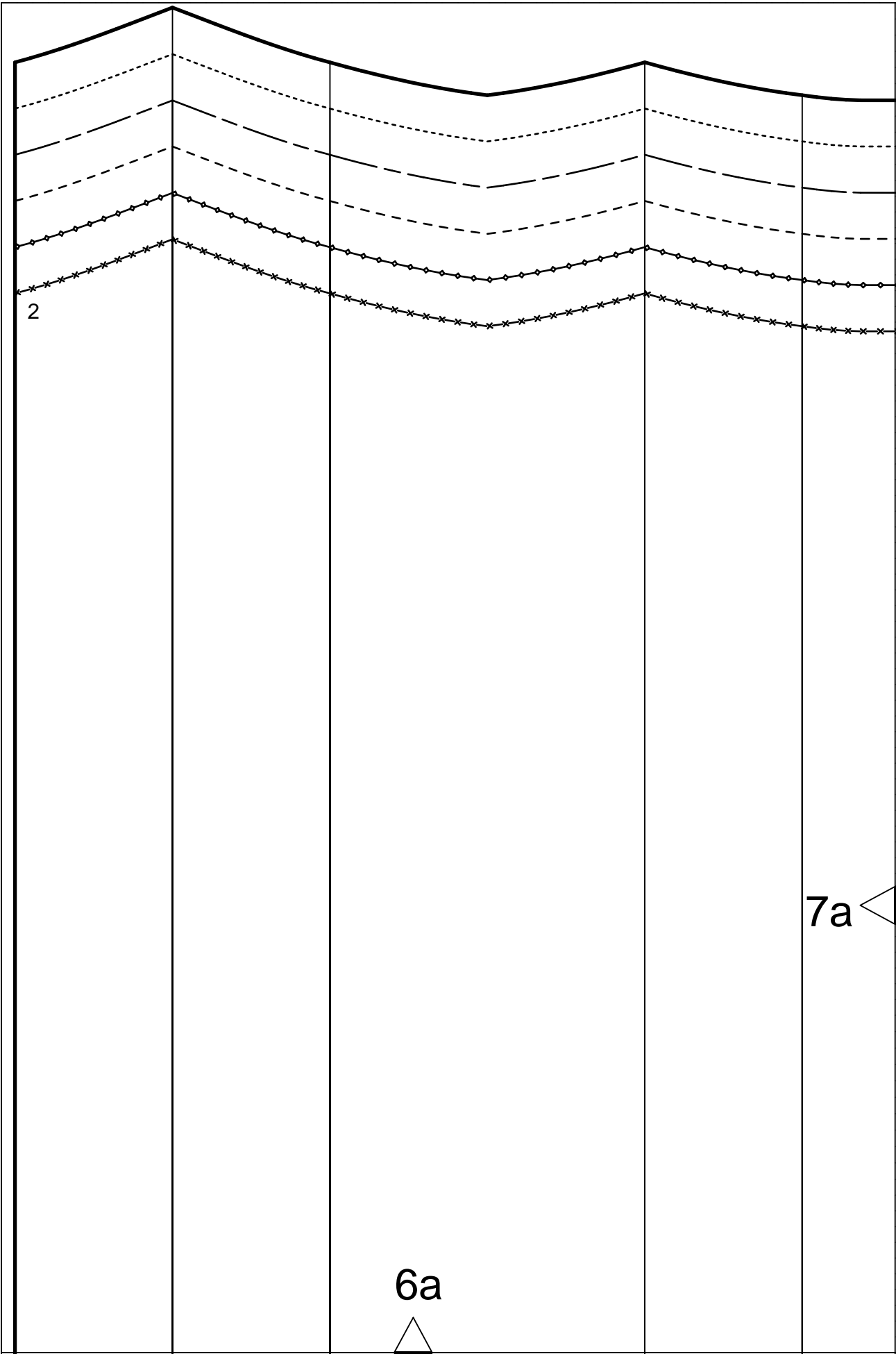

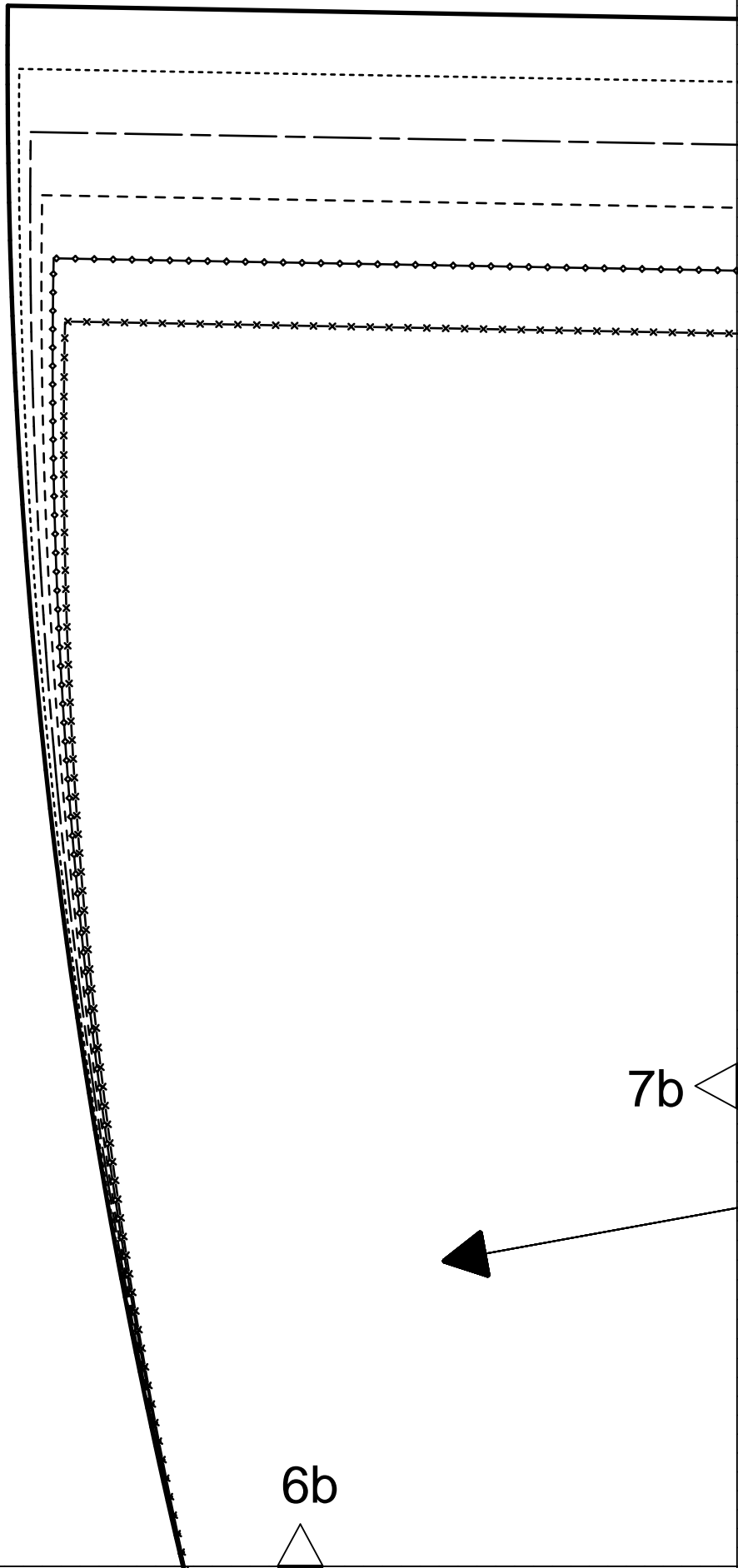
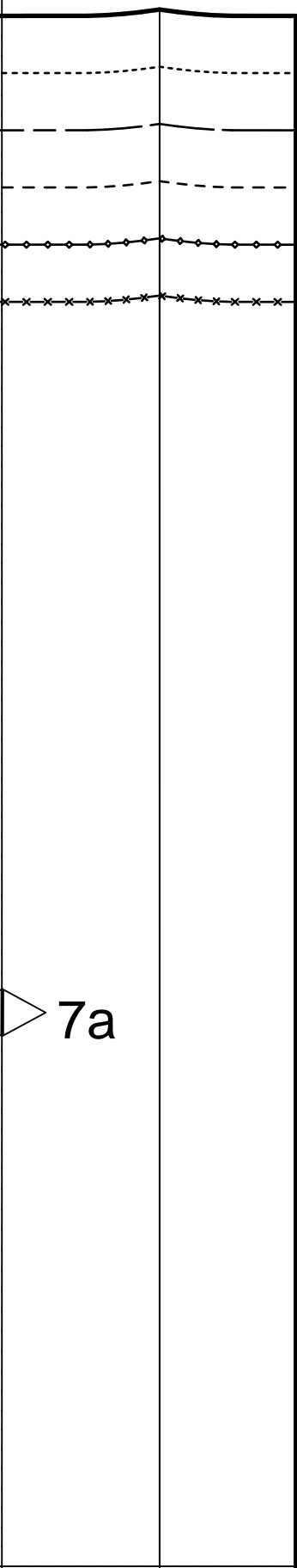

7b

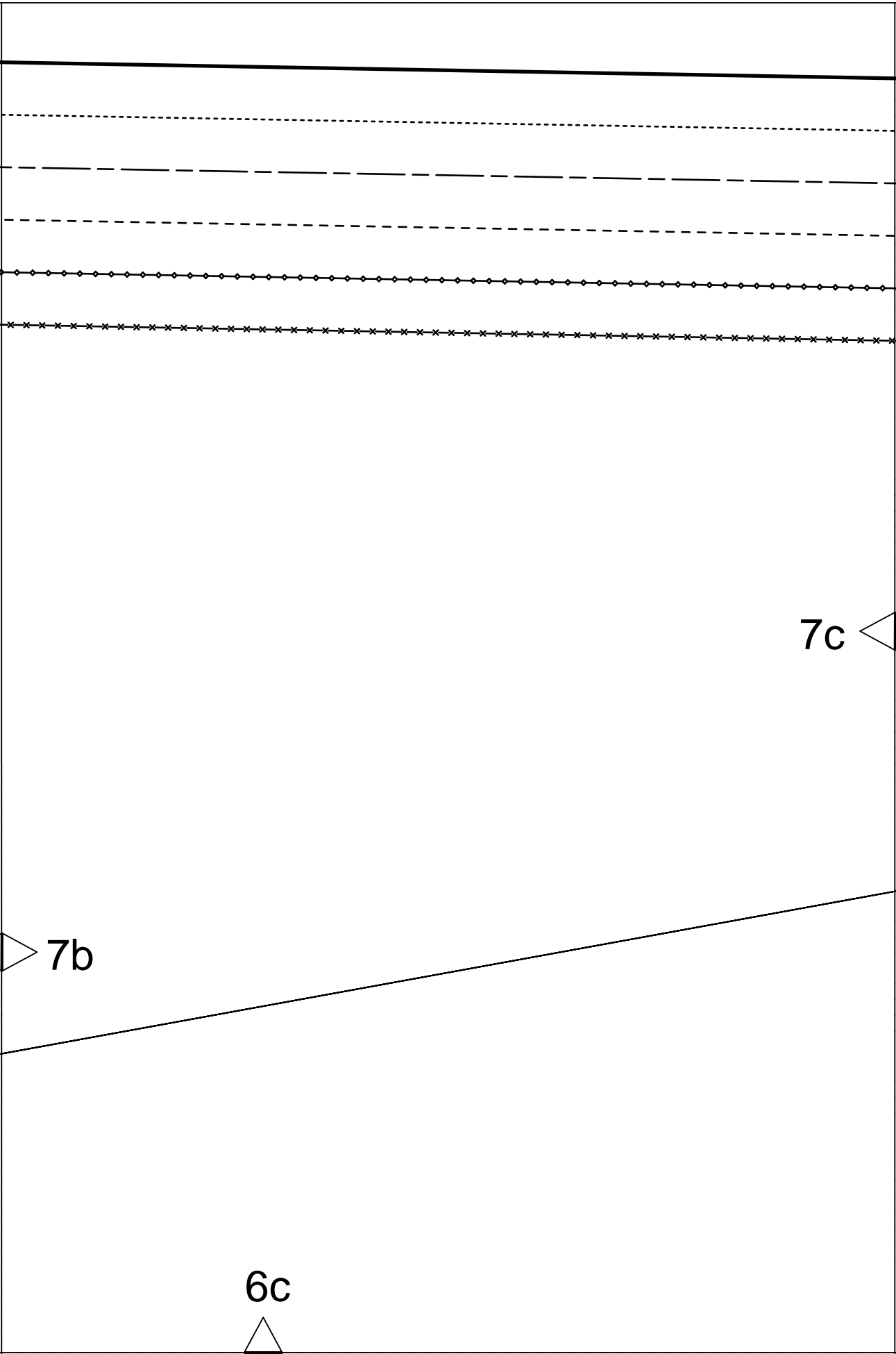

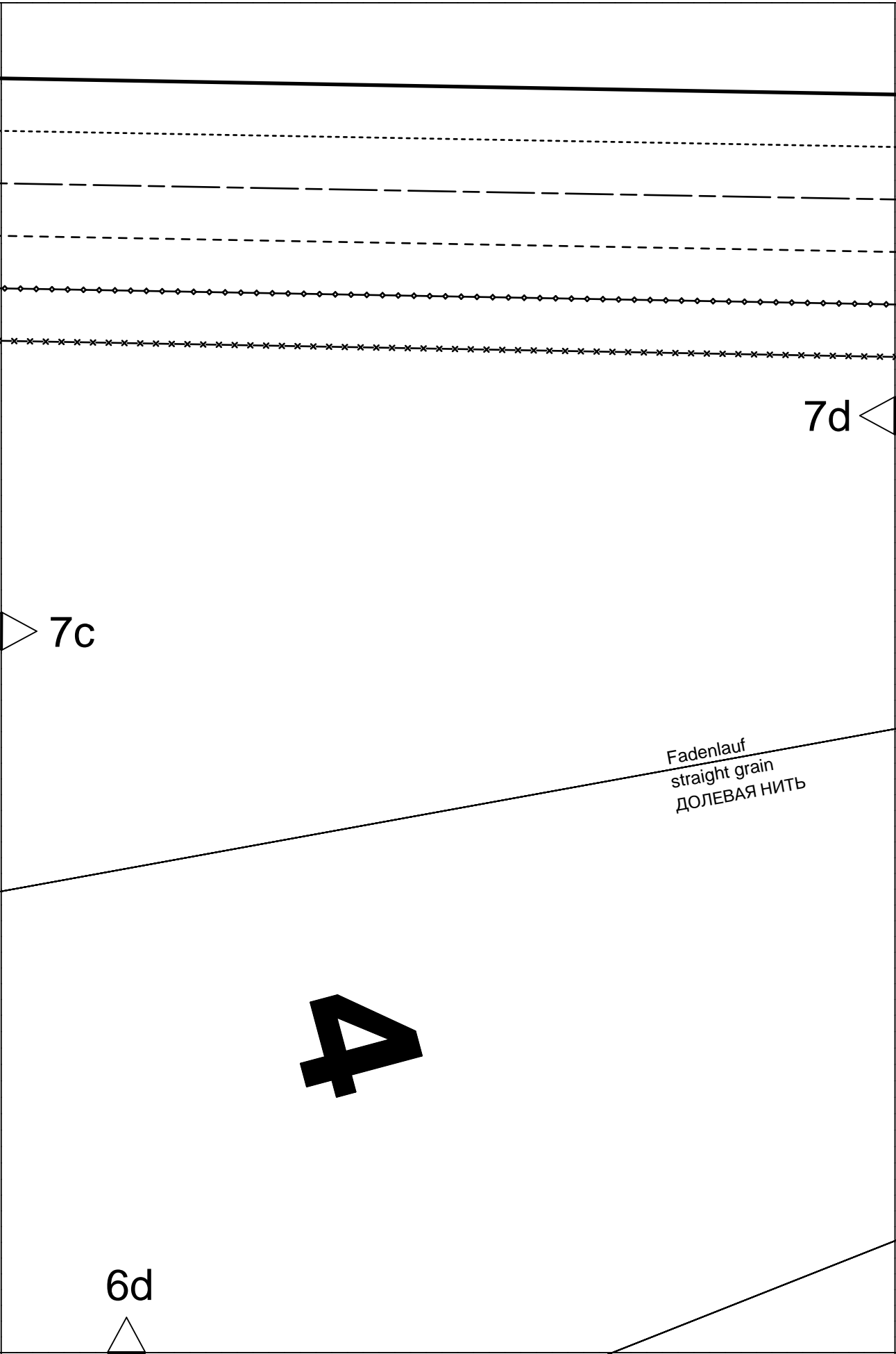

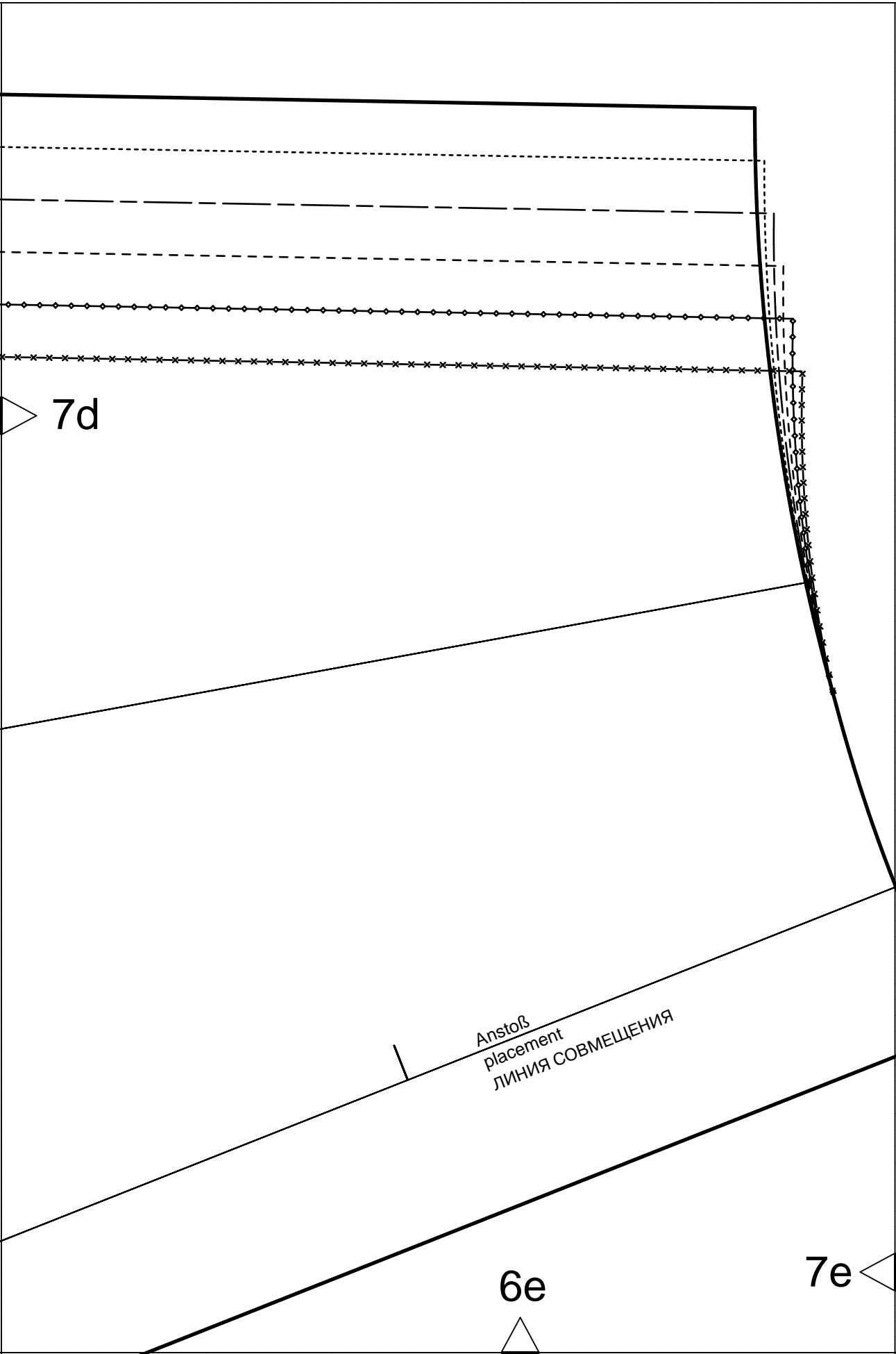

7d

Anstoß  
placement  
ЛИНИЯ СОВМЕЩЕНИЯ

6e

7e

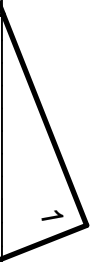
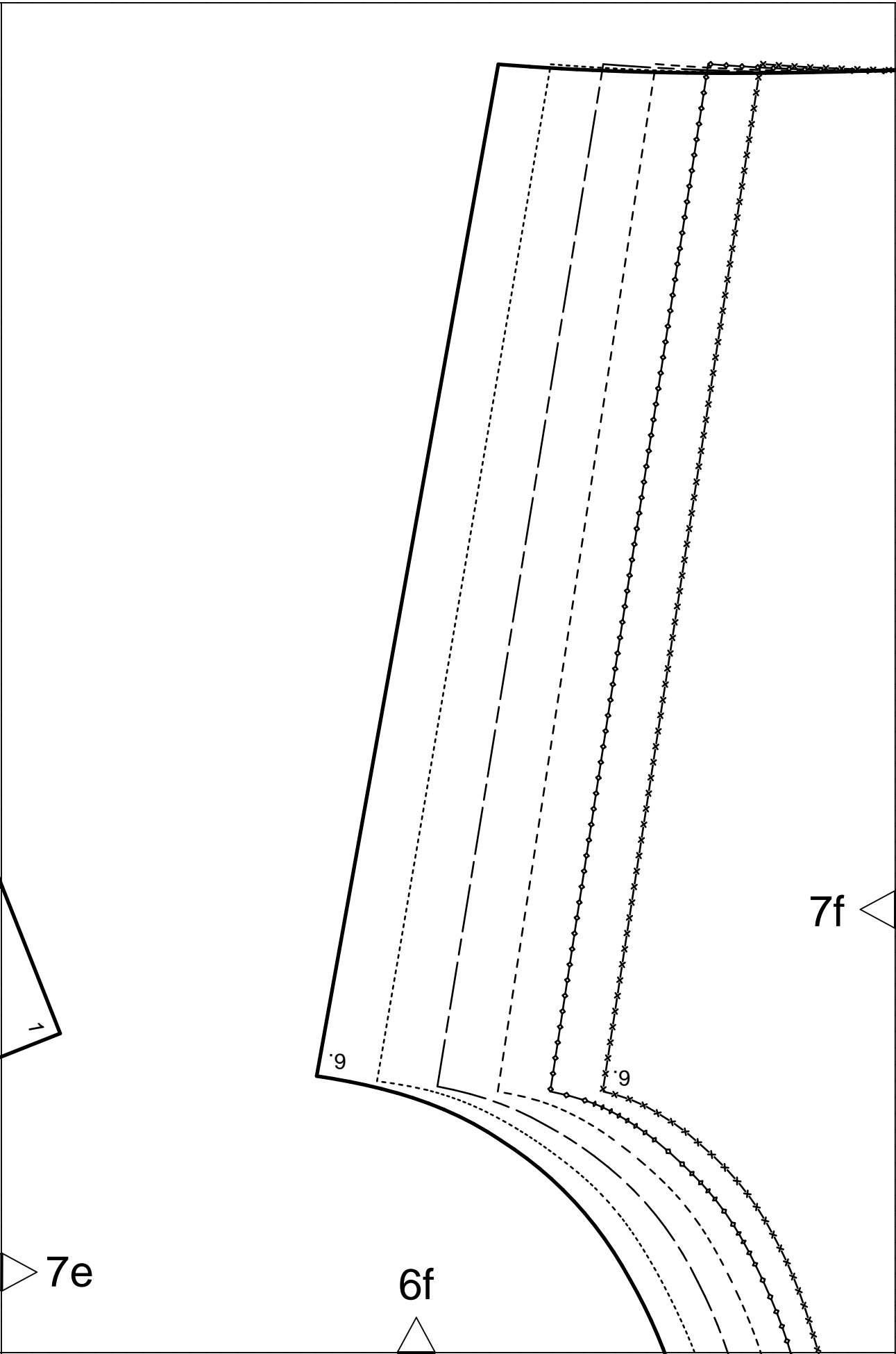

7e

6f

7f

9

9

rückwärtige Mitte Reißverschluss Fadenlauf  
center back zipper straight grain  
ЗАДНЯЯ СЕРЕДИНА МОЛНИИЯ ДОЛБЕВАЯ НИТЬ

6g



7f

